

Multilayer Antenna (Dual Band type)

For 2400-2484MHz / 5150-5850MHz

ANT162442DT-2001A2

1.6x0.8mm [EIA 0603]*

* Dimensions Code JIS[EIA]

Multilayer Antenna

Conformity to RoHS Directive

For 2400-2484MHz / 5150-5850MHz

ANT162442DT-2001A2

SHAPES AND DIMENSIONS

[Top view]

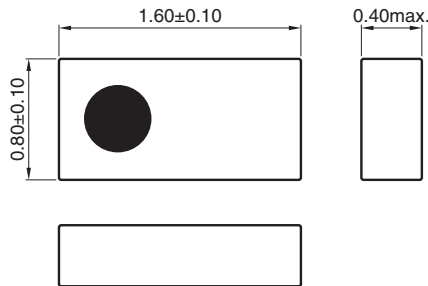

[Bottom view]

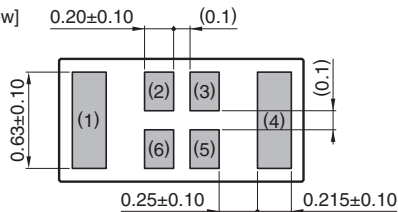

Terminal functions

1	Radiator electrode for 2.4GHz ISM
2	Feed point
3	Feed point
4	Radiator electrode for 5.5GHz
5	Feed point
6	Feed point

Dimensions in mm

RECOMMENDED LAND PATTERN

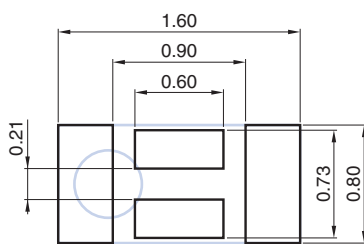

Dimensions in mm

SOLDER RESIST PATTERN

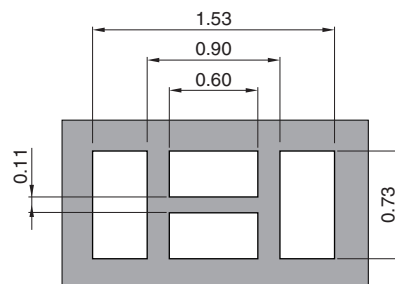

Dimensions in mm

○ RoHS Directive Compliant Product: See the following for more details. <https://product.tdk.com/info/en/environment/rohs/index.html>

- All specifications are subject to change without notice.
- Before using these products, be sure to request the delivery specifications.

ANT162442DT-2001A2

EVALUATION BOARD

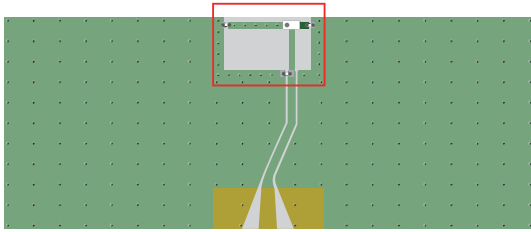

PCB size : 50mm x 20mm x 1mm
Antenna area : 8 x 5 mm

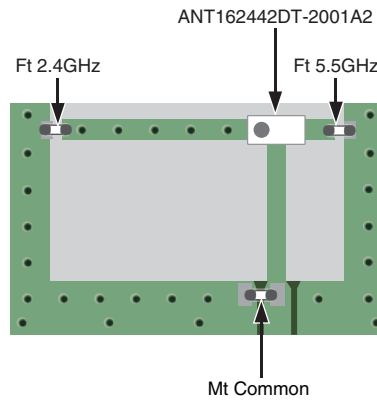

	Component P/N
Ft 2.4GHz	6.2pF
Ft 5.5GHz	0.4pF
Mt Common	1.3nH(MLG1005S1N3C:TDK)

Measurement condition for Radiation Pattern

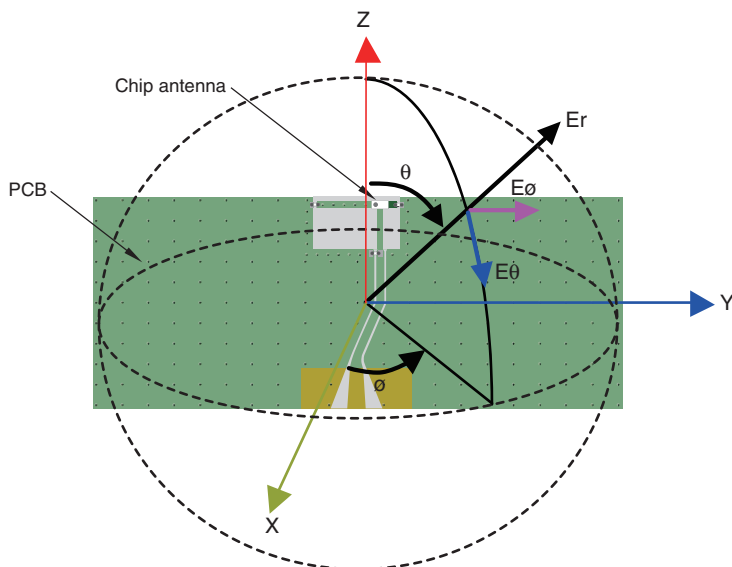

- All specifications are subject to change without notice.
- Before using these products, be sure to request the delivery specifications.

ANT162442DT-2001A2

ELECTRICAL CHARACTERISTICS

Item	Frequency Range (MHz)	Min.	Typ.	Max.
VSWR	2400 to 2484	—	1.54	3.0
	5150 to 5850	—	1.58	3.0
Polarization			Linear	
PCB size (mm)			50×20	
Antenna keep-out area (mm)			8×5	
Characteristic Impedance (Ω)			50 (Nominal)	

• This is typical antenna performance with the standard PCB.

TEMPERATURE RANGE

Operating temperature (°C)	Storage temperature (°C)
-40 to +85	-40 to +85

FREQUENCY CHARACTERISTICS

2.4GHz WLAN BAND

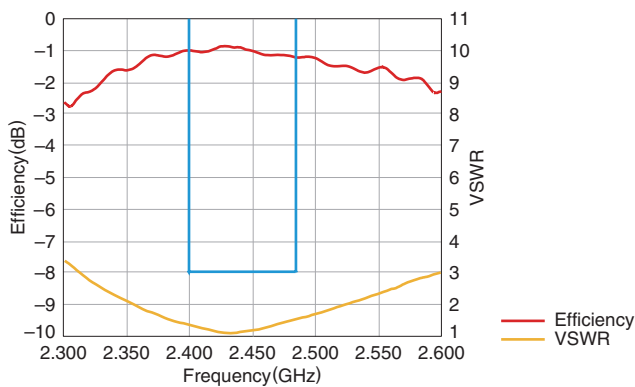

5.5GHz WLAN BAND

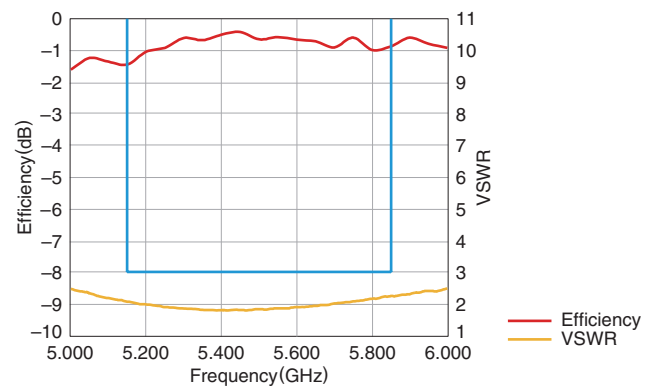

• Tested antenna has been soldered. Evaluation board size is 50x20x1 mm.

ANT162442DT-2001A2

RADIATION PATTERNS

2.4GHz ISM BAND

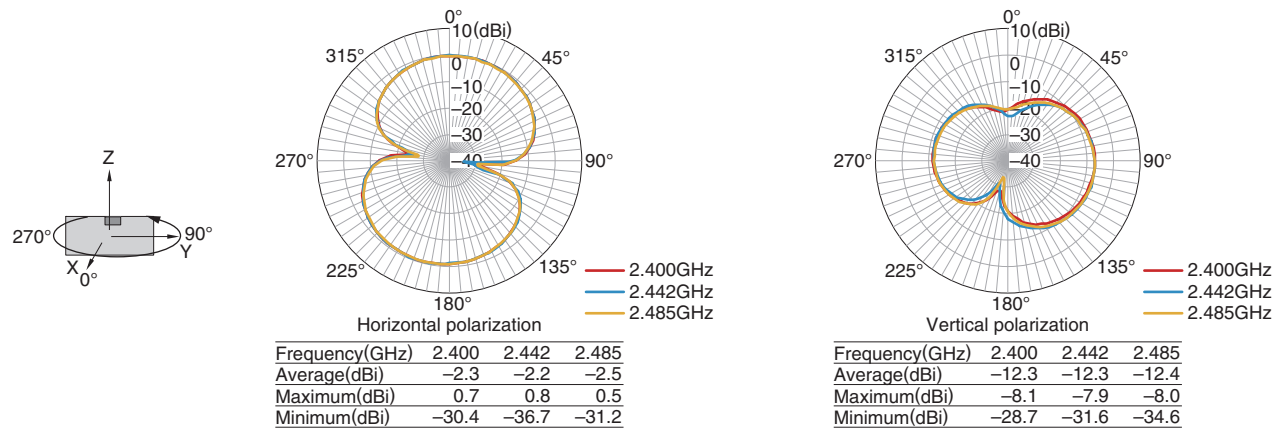
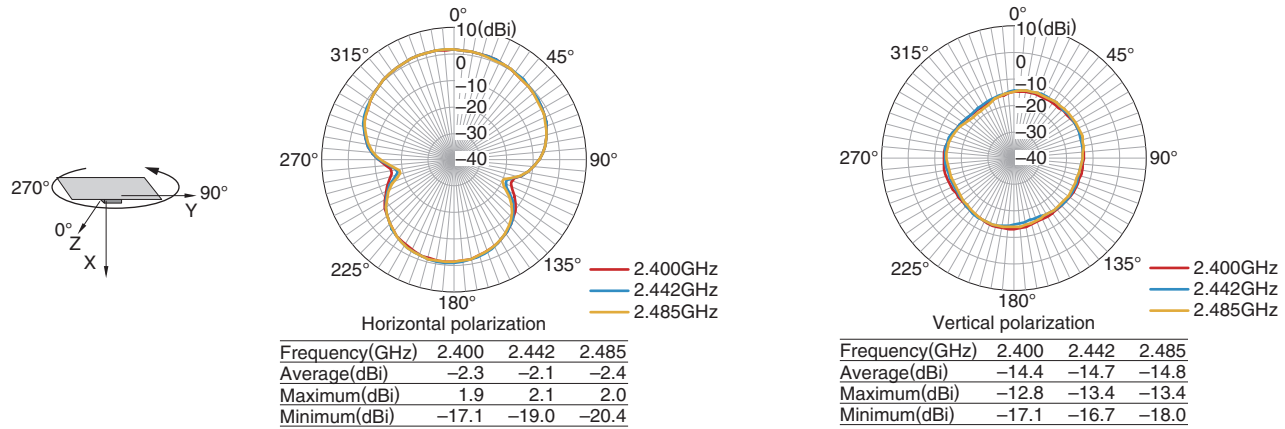
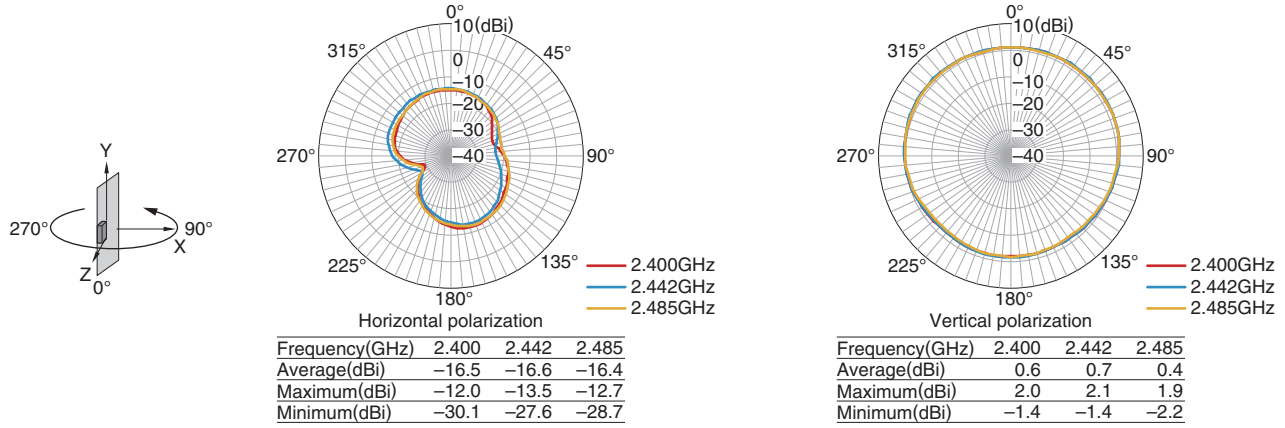

• Tested antenna has been soldered. Evaluation board size is 50x20x1 mm.

- All specifications are subject to change without notice.
- Before using these products, be sure to request the delivery specifications.

ANT162442DT-2001A2

RADIATION PATTERNS

5.5GHZ BAND

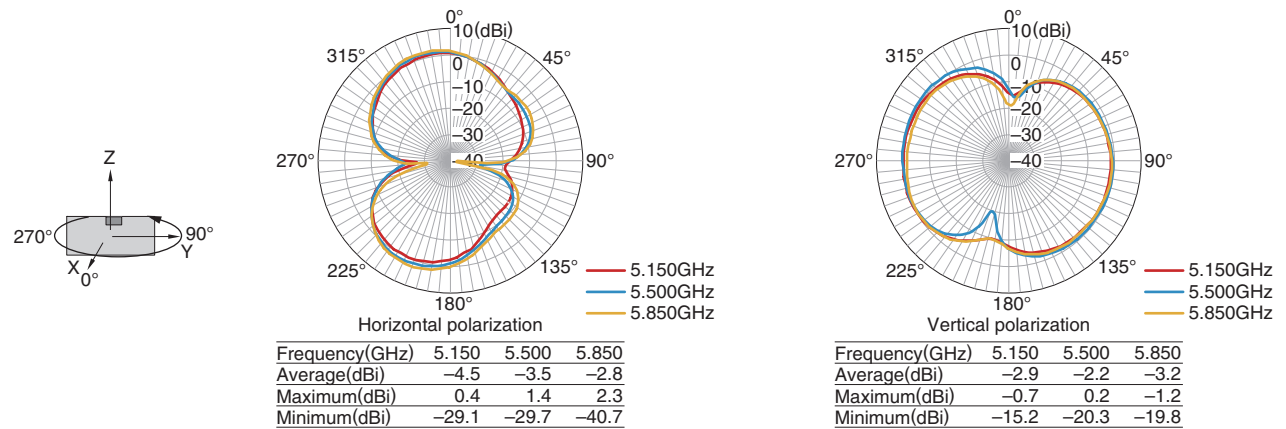
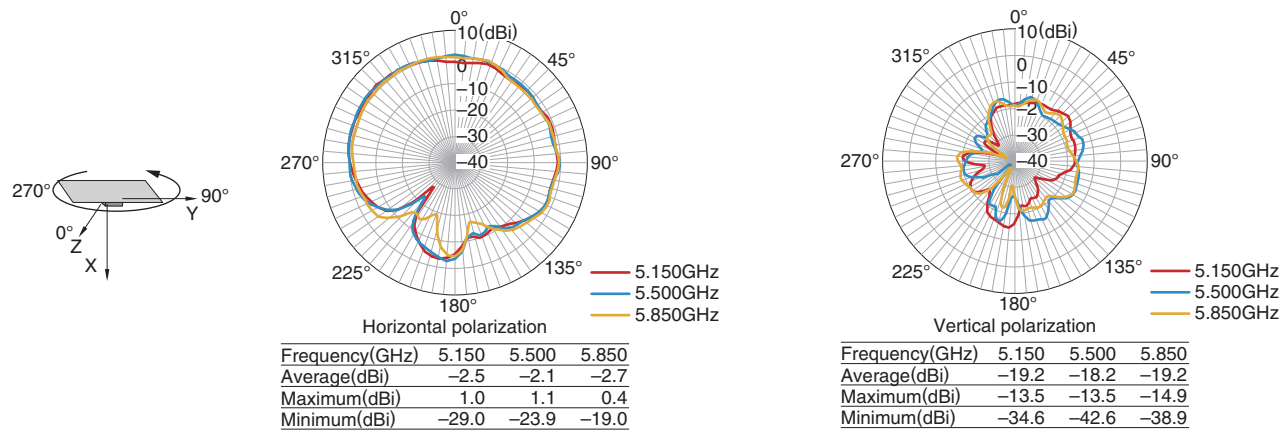
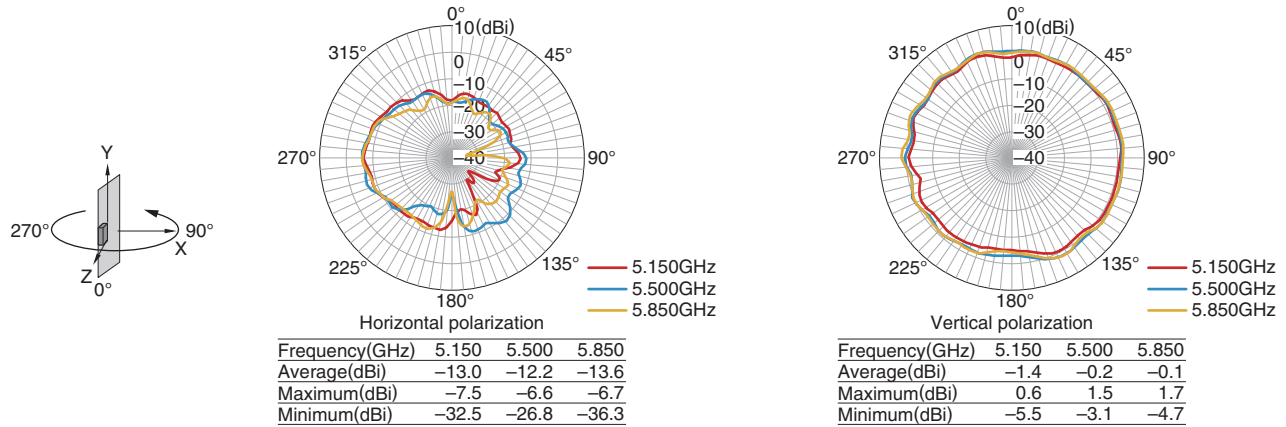

•Tested antenna has been soldered. Evaluation board size is 50x20x1 mm.

- All specifications are subject to change without notice.
- Before using these products, be sure to request the delivery specifications.

ANT162442DT-2001A2

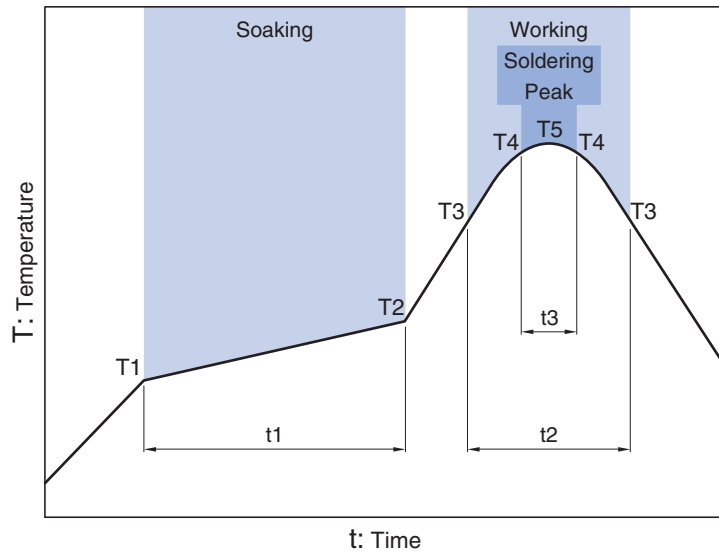
RECOMMENDED REFLOW PROFILE

Soaking			Working		Soldering Peak		
Temp.	T2	Time	Temp.	Time	Temp.	Time	Temp.
T1	T2	t1	T3	t2	T4	t3	T5
150°C	180°C	60 to 120s	230°C	30 to 60s	247 to 253°C	within 10s	260°C max.

- All specifications are subject to change without notice.
- Before using these products, be sure to request the delivery specifications.

ANT162442DT-2001A2

PACKAGING STYLE

REEL DIMENSIONS

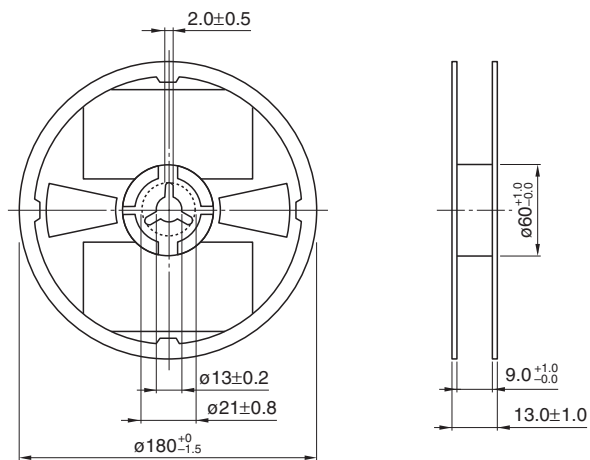

Dimensions in mm

TAPE DIMENSIONS

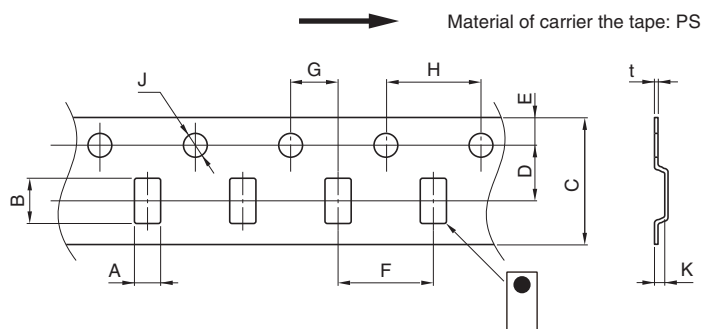

Dimensions in mm

A	B	C	D	E	F	G	H	J	K	t
0.97±0.05	1.8±0.05	8.0±0.2	3.5±0.05	1.75±0.1	4.0±0.1	2.0±0.05	4.0±0.1	1.5+0.1/-0	0.55max.	0.25±0.05

PACKAGE QUANTITY

Standard package quantity
(pieces/reel)

4,000

- All specifications are subject to change without notice.
- Before using these products, be sure to request the delivery specifications.

REMINDERS FOR USING THESE PRODUCTS

Before using these products, be sure to request the delivery specifications.

SAFETY REMINDERS

Please pay sufficient attention to the warnings for safe designing when using these products.

REMINDERS

The products listed on this catalog are intended for use in general electronic equipment (AV equipment, telecommunications equipment, home appliances, amusement equipment, computer equipment, personal equipment, office equipment, measurement equipment, industrial robots) under a normal operation and use condition.

The products are not designed or warranted to meet the requirements of the applications listed below, whose performance and/or quality require a more stringent level of safety or reliability, or whose failure, malfunction or trouble could cause serious damage to society, person or property.

Please understand that we are not responsible for any damage or liability caused by use of the products in any of the applications below or for any other use exceeding the range or conditions set forth in this catalog.

- | | |
|---|--|
| (1) Aerospace/Aviation equipment | (8) Public information-processing equipment |
| (2) Transportation equipment (cars, electric trains, ships, etc.) | (9) Military equipment |
| (3) Medical equipment | (10) Electric heating apparatus, burning equipment |
| (4) Power-generation control equipment | (11) Disaster prevention/crime prevention equipment |
| (5) Atomic energy-related equipment | (12) Safety equipment |
| (6) Seabed equipment | (13) Other applications that are not considered general-purpose applications |
| (7) Transportation control equipment | |

When using this product in general-purpose applications, you are kindly requested to take into consideration securing protection circuit/equipment or providing backup circuits, etc., to ensure higher safety.